



# Modulazione del microclima nelle stalle da latte

Lorenzo Leso, Phd  
Università di Palermo, SAAF  
Rota Guido Srl

**18/03/2025**  
***STRESS DA CALDO: CLIMATIZZAZIONE E  
TECNOLOGIE***  
Università Cattolica, Cremona



**4/12=0.33 -> 33% vacche in piedi in cuccetta!!! (<10%)**



# Effetto temperatura su tempo di riposo

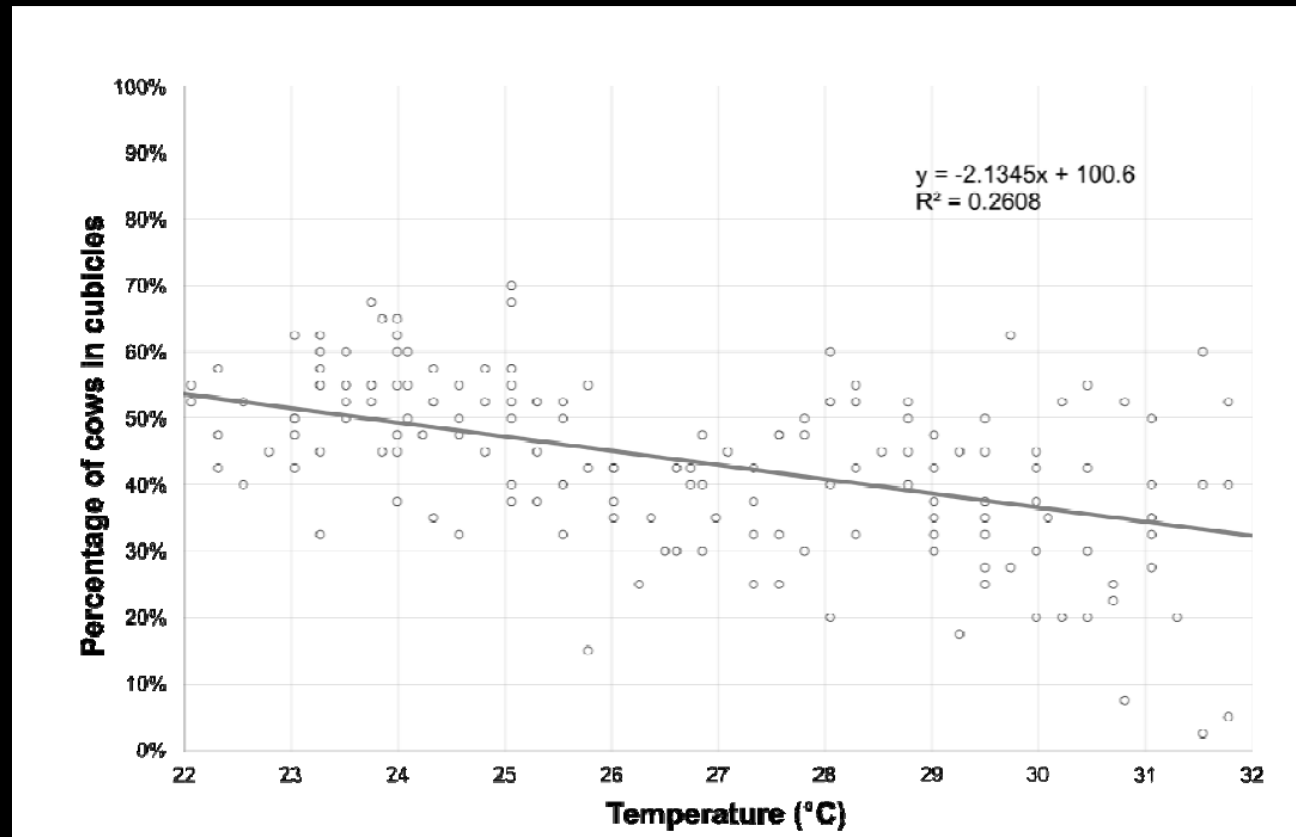

**Tempo di riposo = n. atti riposo \* durata atti riposo**

	Normale (68.5 THI)	Stress da caldo (79 THI)
Atti di riposo	11.7 n./gg	11.7 n./gg
Durata atti di riposo	49 min./atto	<b>33 min./atto</b>
Tempo di riposo	9.5 h/gg	6.2 h/gg

Nordlund et al., 2019

**RANGE**

**+0.28 °C/h**

**+0.76 °C/h**

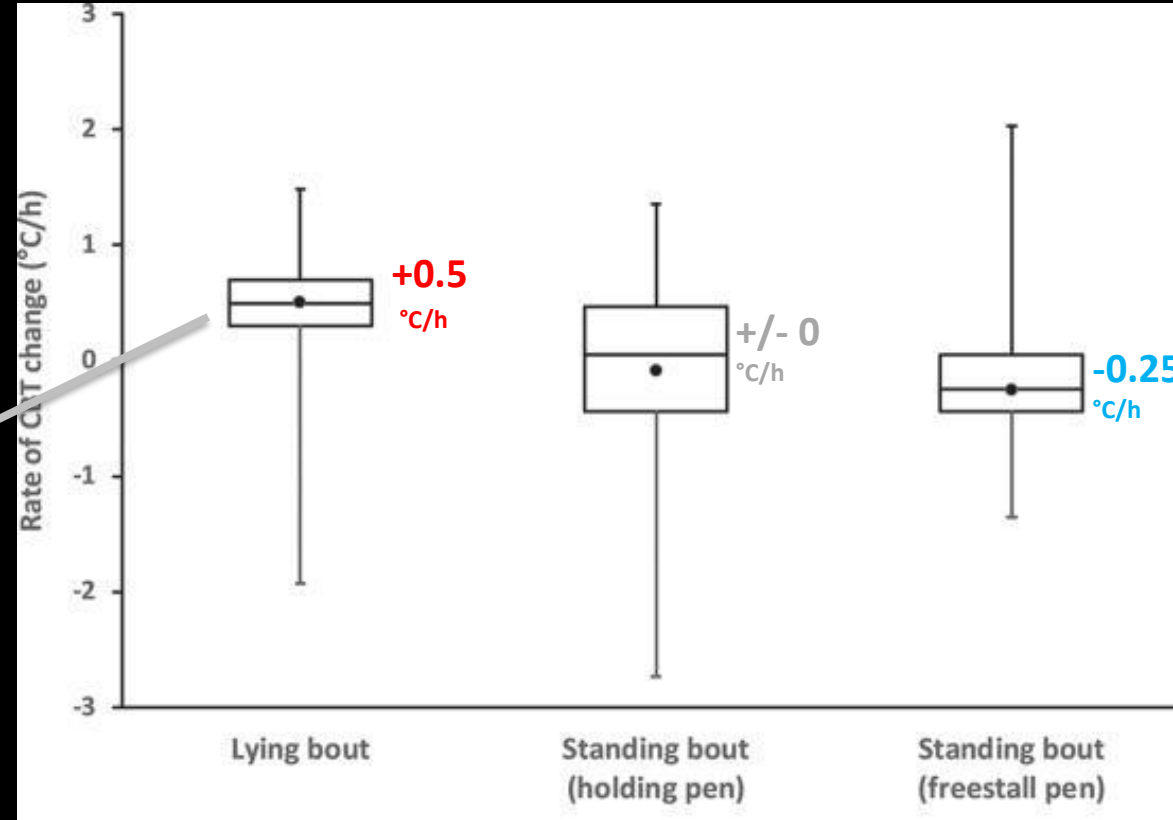

STRESS DA CALDO >68 THI



ADATTAMENTI  
METABOLICI

ADATTAMENTI  
COMPORAMENTALI

Riduzione prod. Latte  
Riduzione fertilità

Aumento rischio zoppie

Tempo di riposo

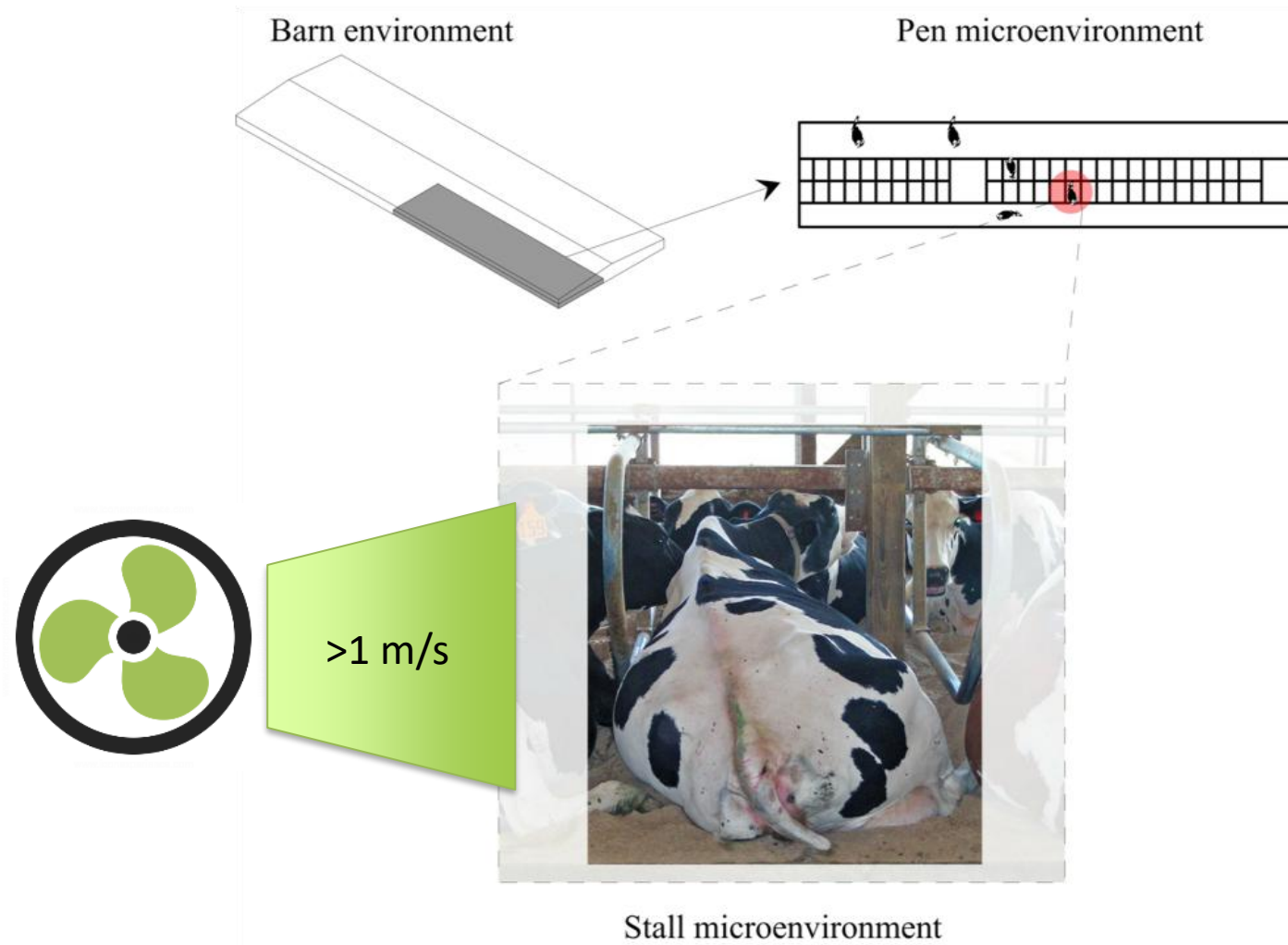



Velocità dell'aria per disperdere calore

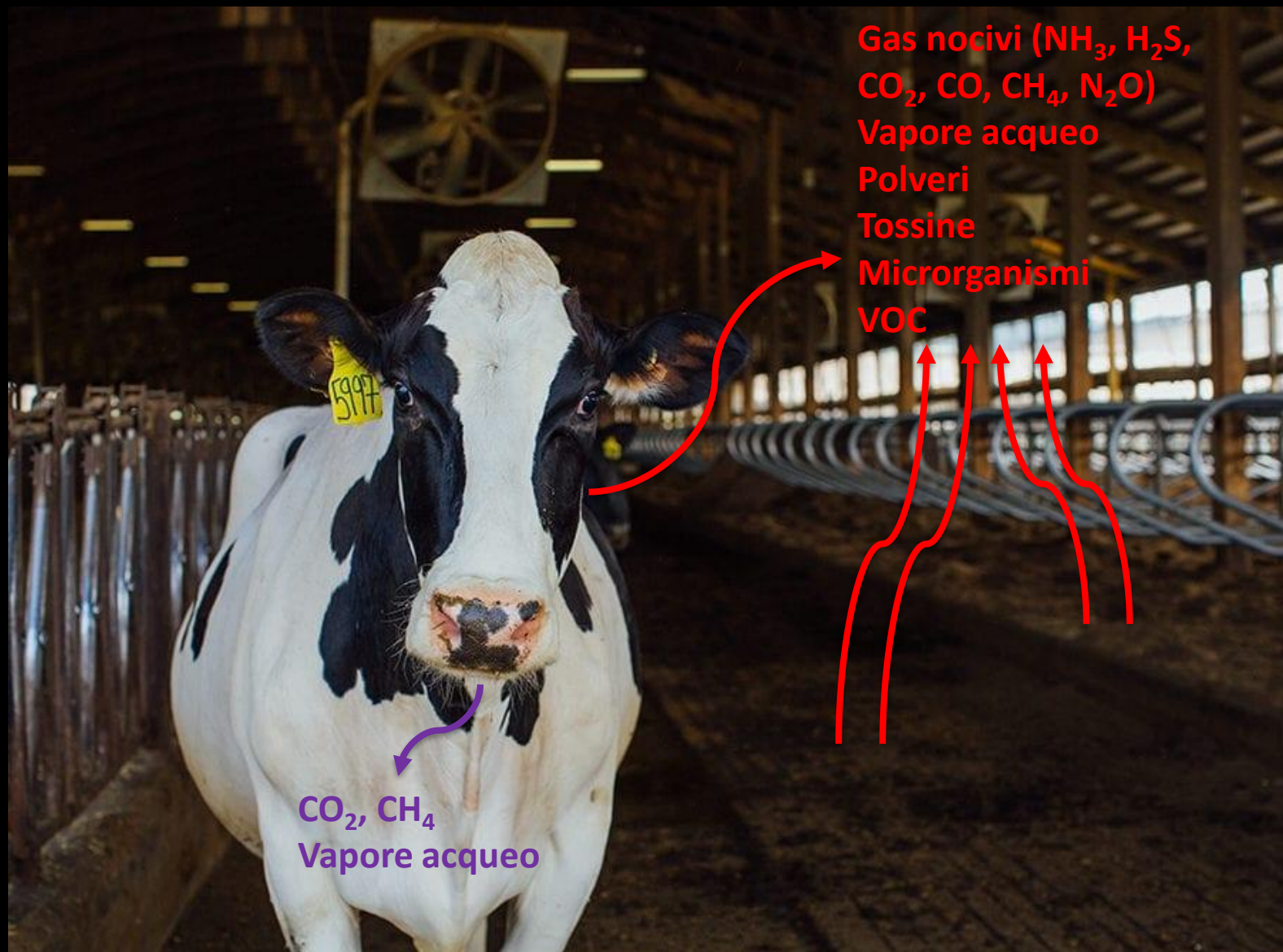

Gas nocivi ( $\text{NH}_3$ ,  $\text{H}_2\text{S}$ ,  
 $\text{CO}_2$ ,  $\text{CO}$ ,  $\text{CH}_4$ ,  $\text{N}_2\text{O}$ )  
Vapore acqueo  
Polveri  
Tossine  
Microrganismi  
VOC

$\text{CO}_2$ ,  $\text{CH}_4$   
Vapore acqueo

Favorire ricambio d'aria per garantire qualità dell'aria

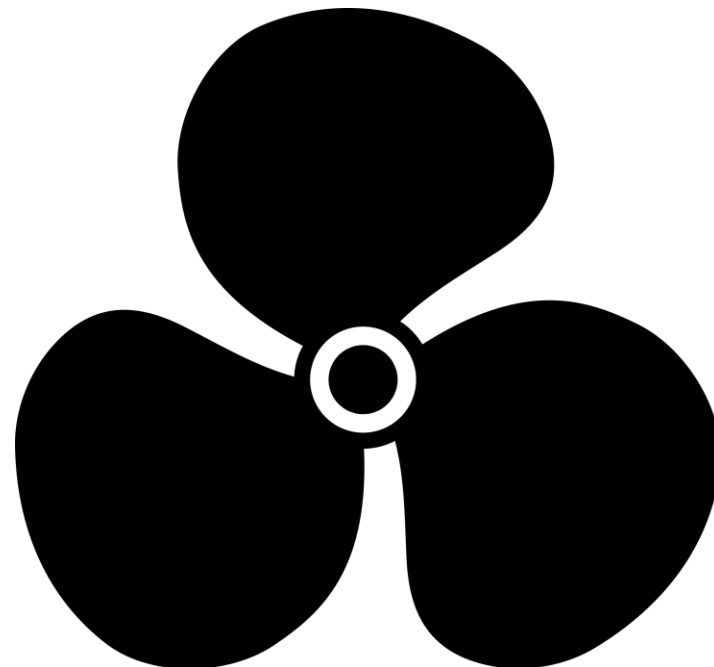

## Velocità dell'aria

Estate= >1 (2) m/s

Inverno= 0.5 m/s



## Ricambio d'aria

Estate= 40-60 AEH

(2500 m<sup>3</sup>/capo\*h)

Inverno= 4-8 AEH

# Misurare il tasso di ventilazione (AEH) in stalle a ventilazione naturale (lati aperti) è particolarmente complesso...

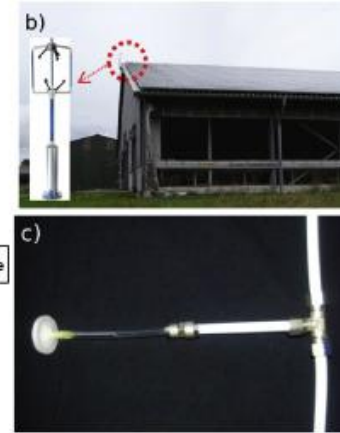
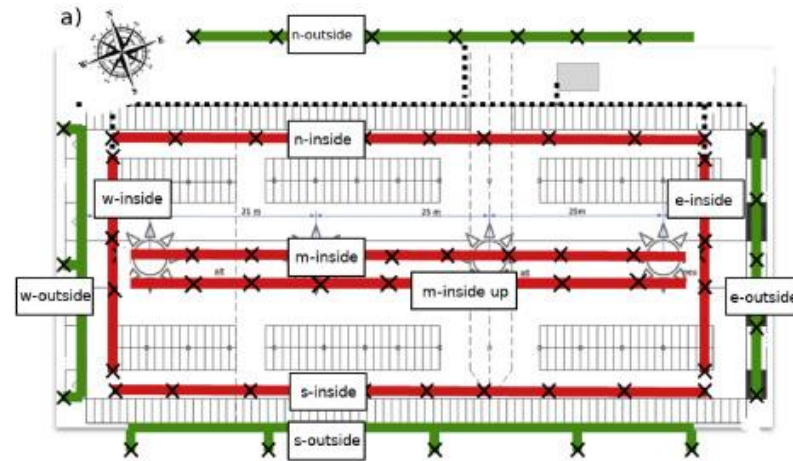

**Metodi diretti**  
**Mass balance (CO<sub>2</sub>)**  
**Tracer gas (CO<sub>2</sub>/SF<sub>6</sub>)**

Janke et al., 2020

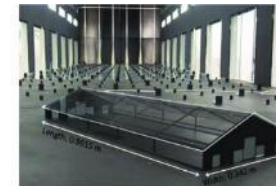
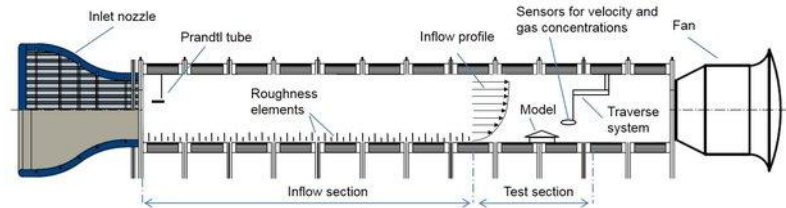

**Simulazione in scala**  
**ridotta/galleria del**  
**vento**

Janke, 2021

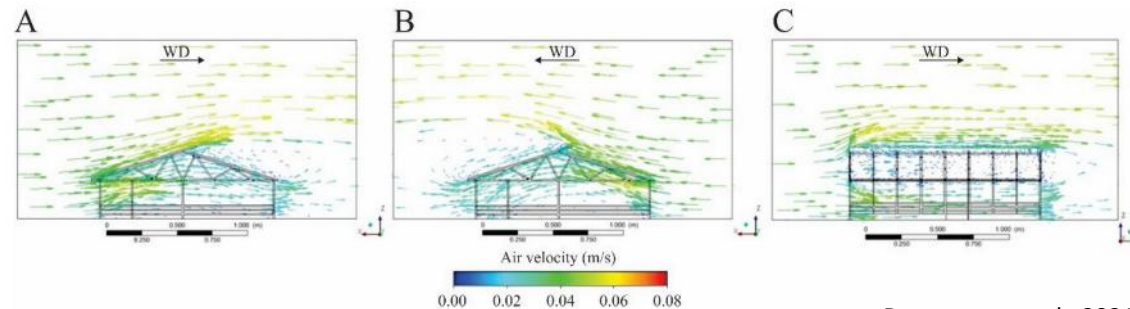

**Simulazione CFD**

Damasceno et al., 2021

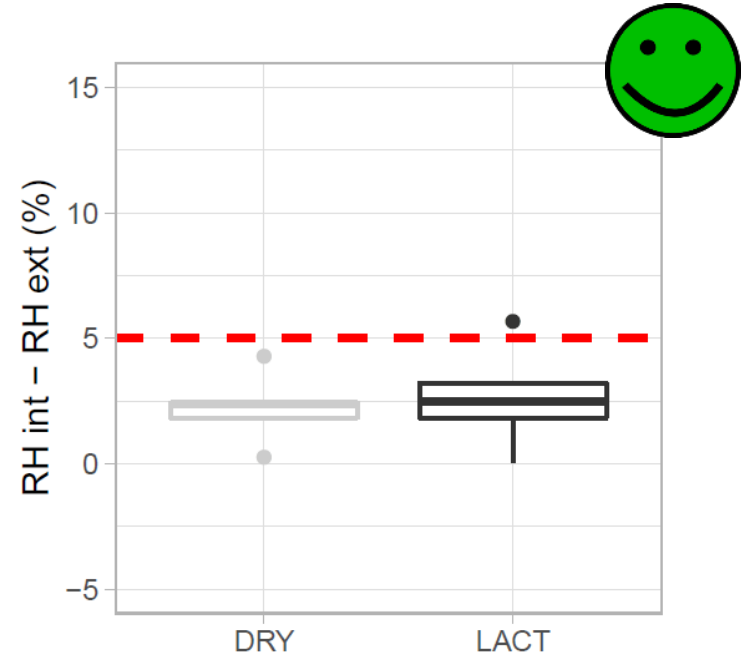
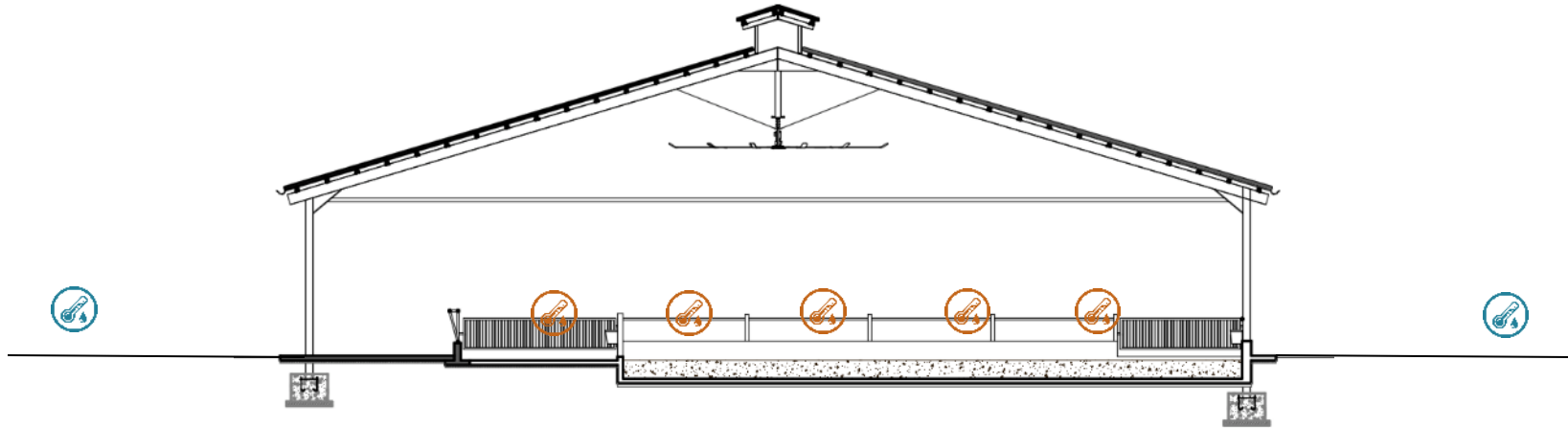

**RH<sub>int</sub> – RH<sub>ext</sub> < 5%**



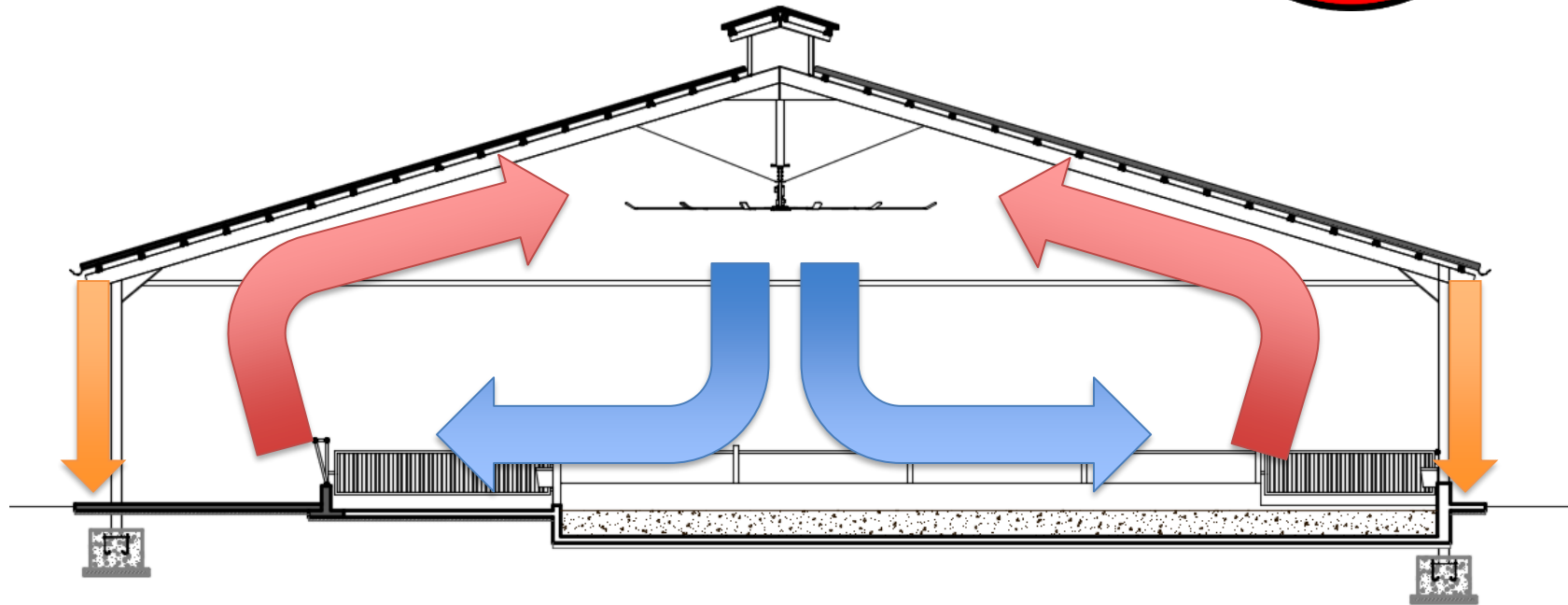





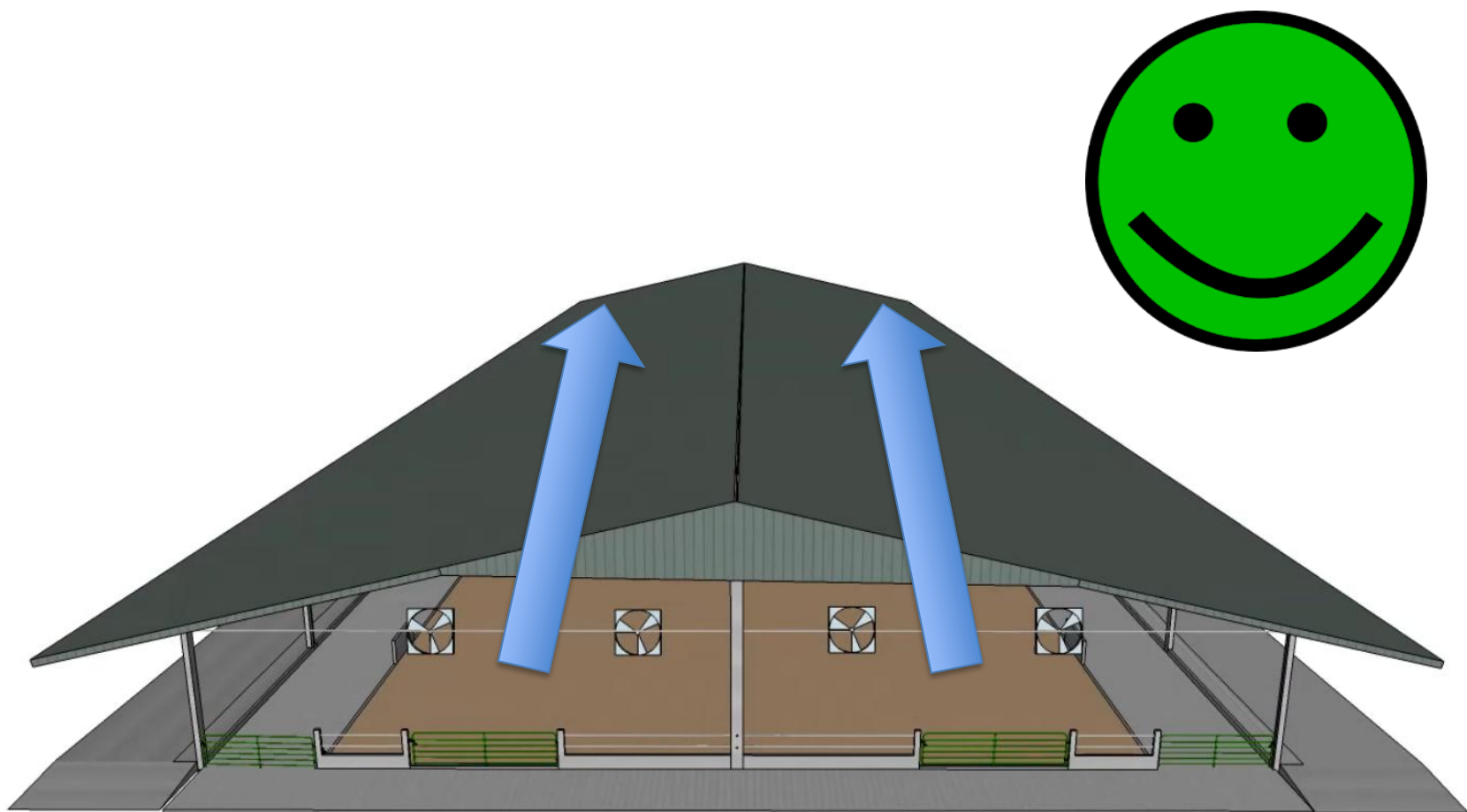

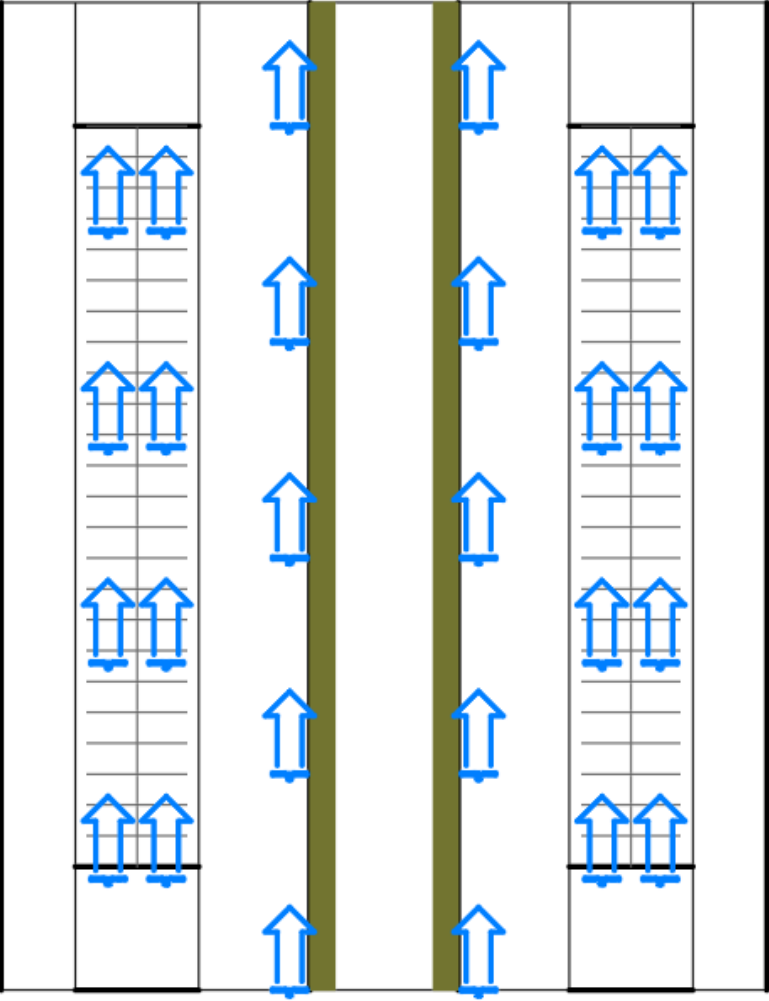
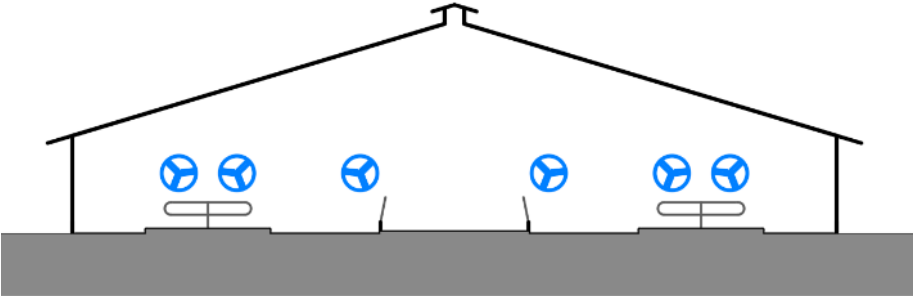



~20 ft (6 m)  
before the air reaches the floor

~50 ft (15 m)  
before the jet loses momentum

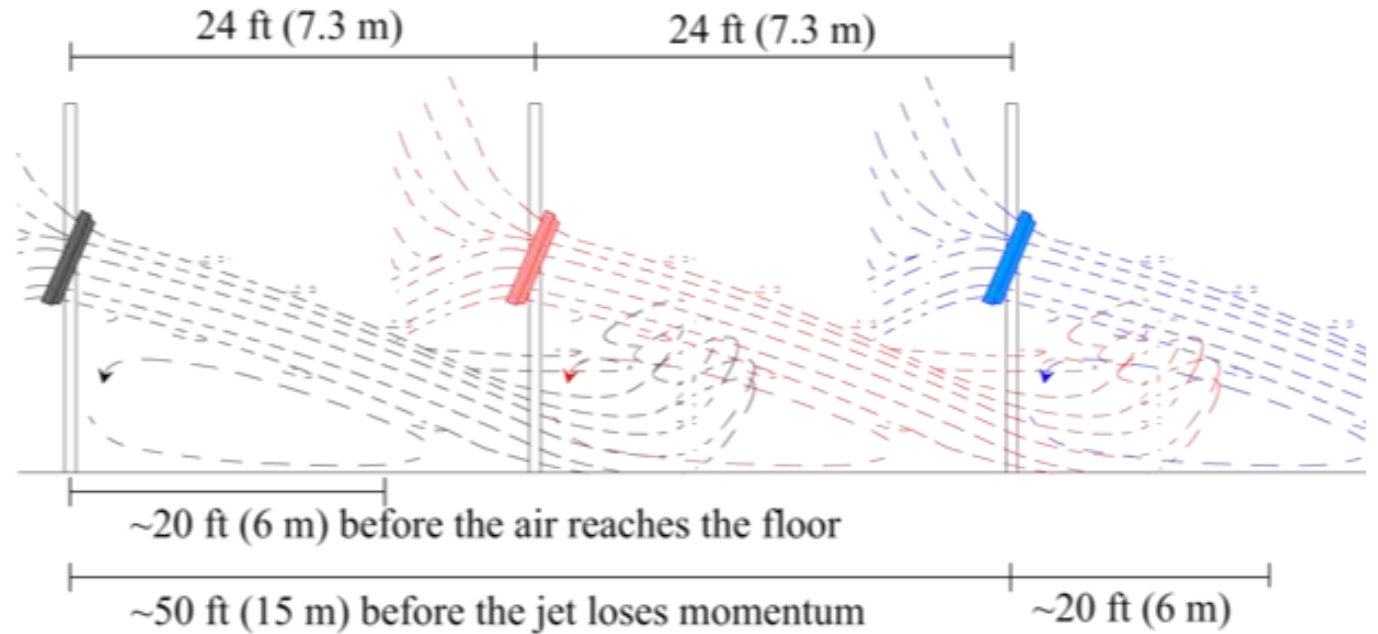

\*Fino a qualche anno fa, per il dimensionamento dell'impianto di ventilazione si usava la regola generale che prevedeva di installare, su ogni fila di cuccette, i ventilatori ad una distanza pari a 10 volte il loro diametro. In realtà questa distanza dovrebbe essere ridotta



## EFFETTO CAMINO

Funziona quando si forma un differenziale (positivo) di temperature tra l'interno e l'esterno dell'edificio

- **FUNZIONA SOLO IN INVERNO**  
Temperatura aria esterna bassa
- **DIPENDE DA DIFFERENZA ALTEZZA APERTURE VENTILAZIONE USCITA E INGRESSO**
  - **Pendenza copertura (>25%)**

## EFFETTO VENTO

Funziona grazie all'azione del vento

- **FUNZIONA SIA IN ESTATE CHE IN INVERNO**
- **DIPENDE DA ORIENTAMENTO E APERTURE DI VENTILAZIONE**
  - Altezza in gronda
  - Apertura pareti (!Tende frangivento!)

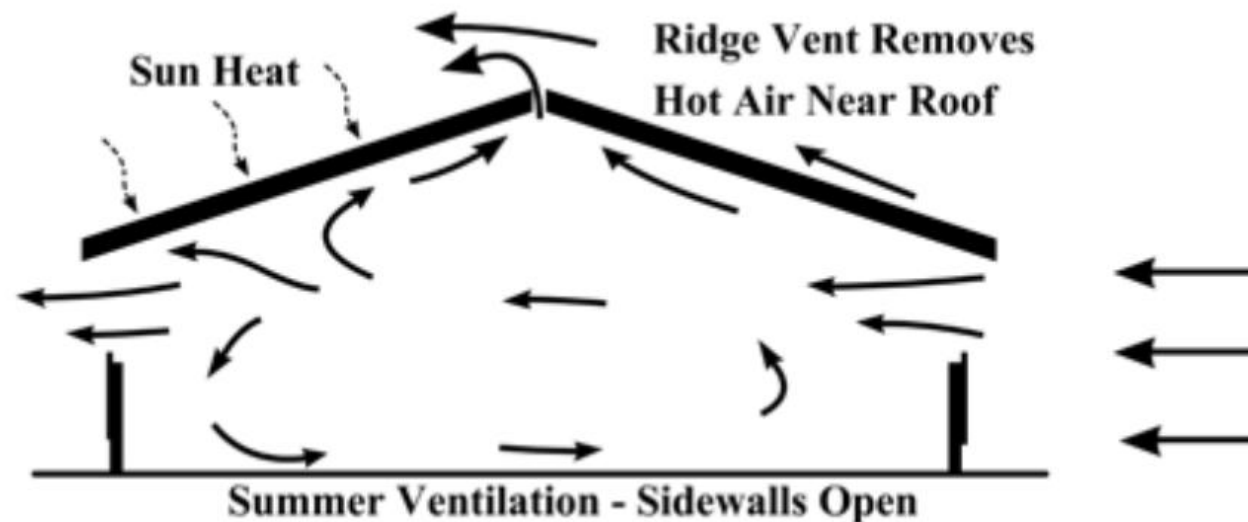

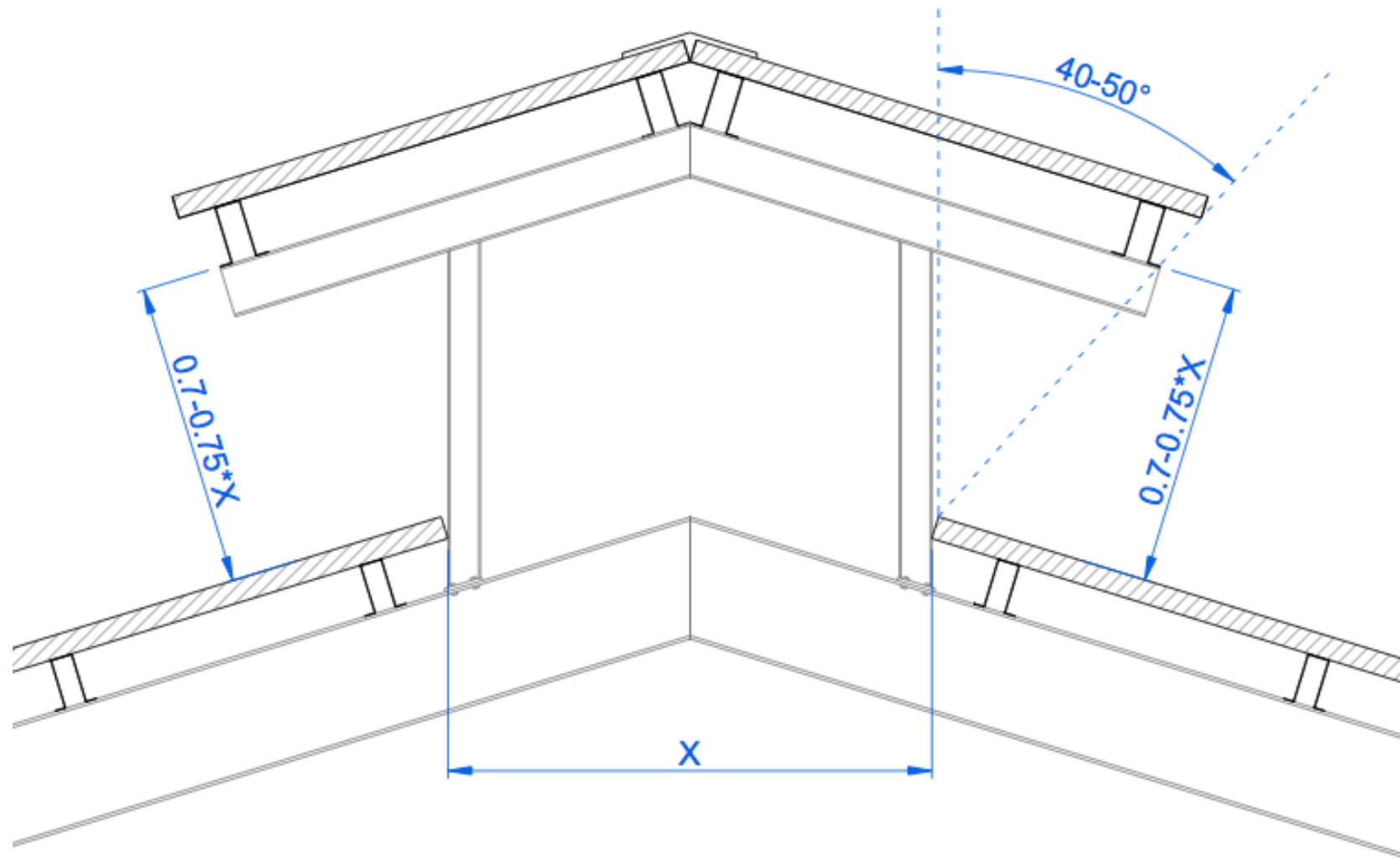

$X = 2-2.5\text{cm}$  per ogni metro di larghezza della stalla



# ORIENTAMENTO DELL'EDIFICIO

Quando si parla di orientamento si definisce una direzione parallela all'asse centrale della stalla (lunghezza)

L'orientamento ottimale si definisce in base a:

## 1. DIREZIONE VENTI DOMINANTI

Orientamento perpendicolare a direzione vento

## 2. ANGOLO SOLARE

Un orientamento **EST-OVEST** è sempre preferibile

## 3. ALTRI

Necessità specifiche della struttura

Presenza di altri edifici

Disponibilità spazio e forma sito

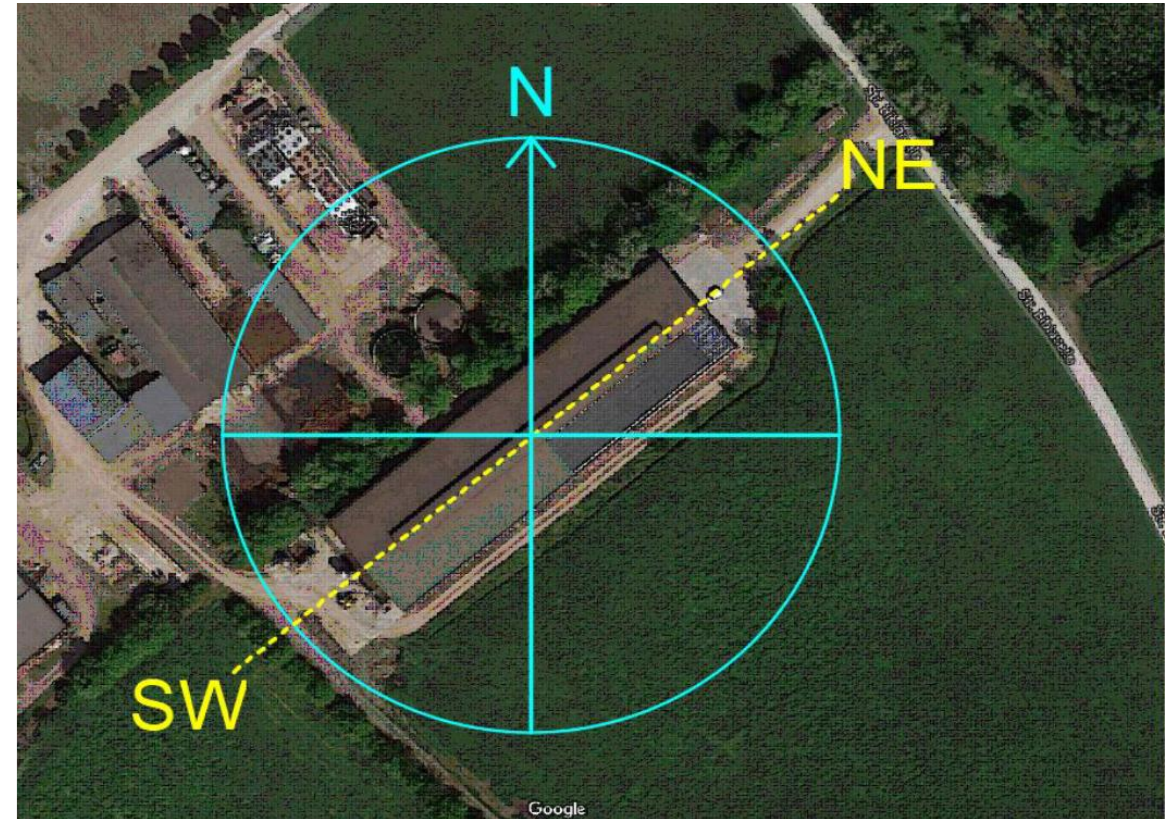

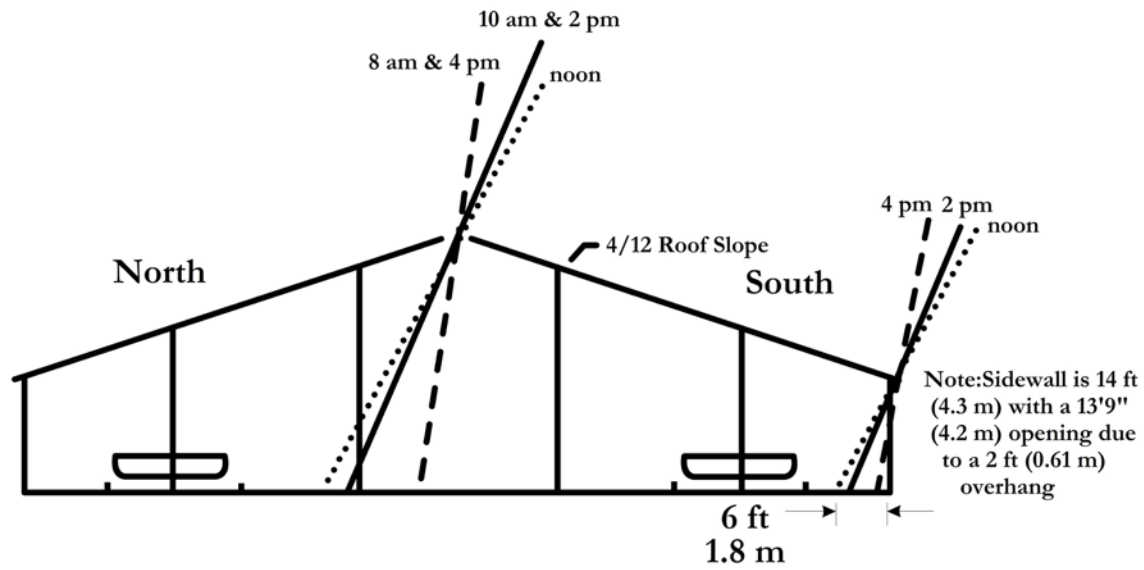

**EST-OVEST**

**NORD-SUD**

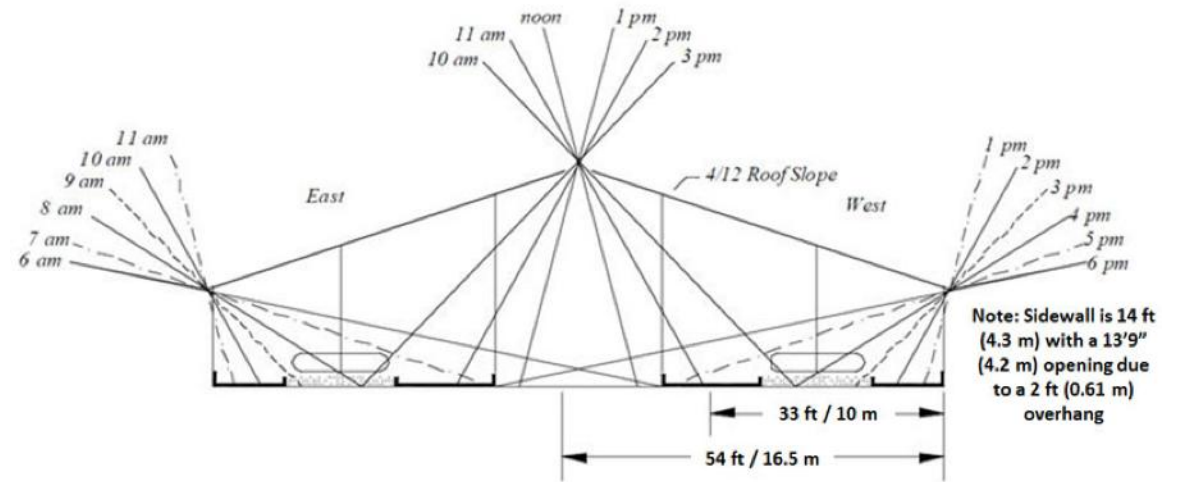



## DISTANZA TRA EDIFICI (WIND SHADOW)

Edifici adiacenti possono bloccare il vento

Per evitare wind shadow è necessario rispettare distanze tra edifici

$$D_{\min} = (0,4 \times \text{altezza edificio}) \times \text{lunghezza edificio}^{0,5}$$

ESEMPIO1:  $D_{\min} = 0,4 \times 6\text{m} \times 50\text{m}^{0,5} = 17\text{m}$

ESEMPIO2:  $D_{\min} = 0,4 \times 10\text{m} \times 100\text{m}^{0,5} = 40\text{m}$

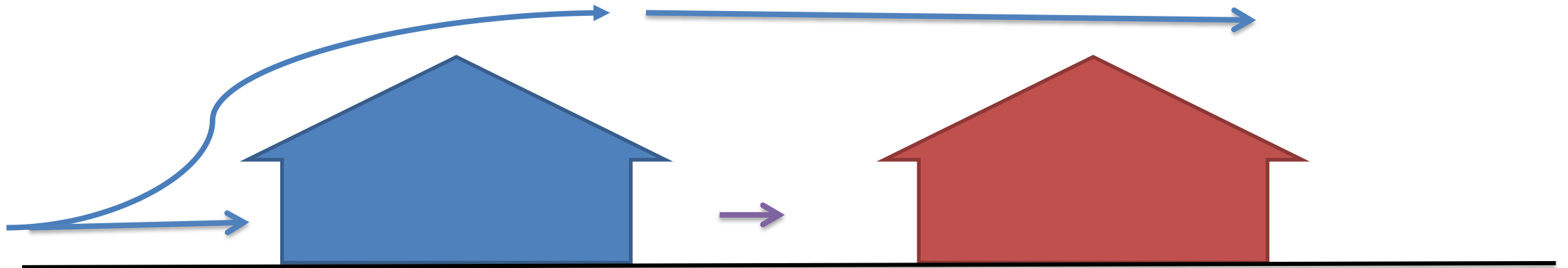



# Stalle a ventilazione “meccanica”

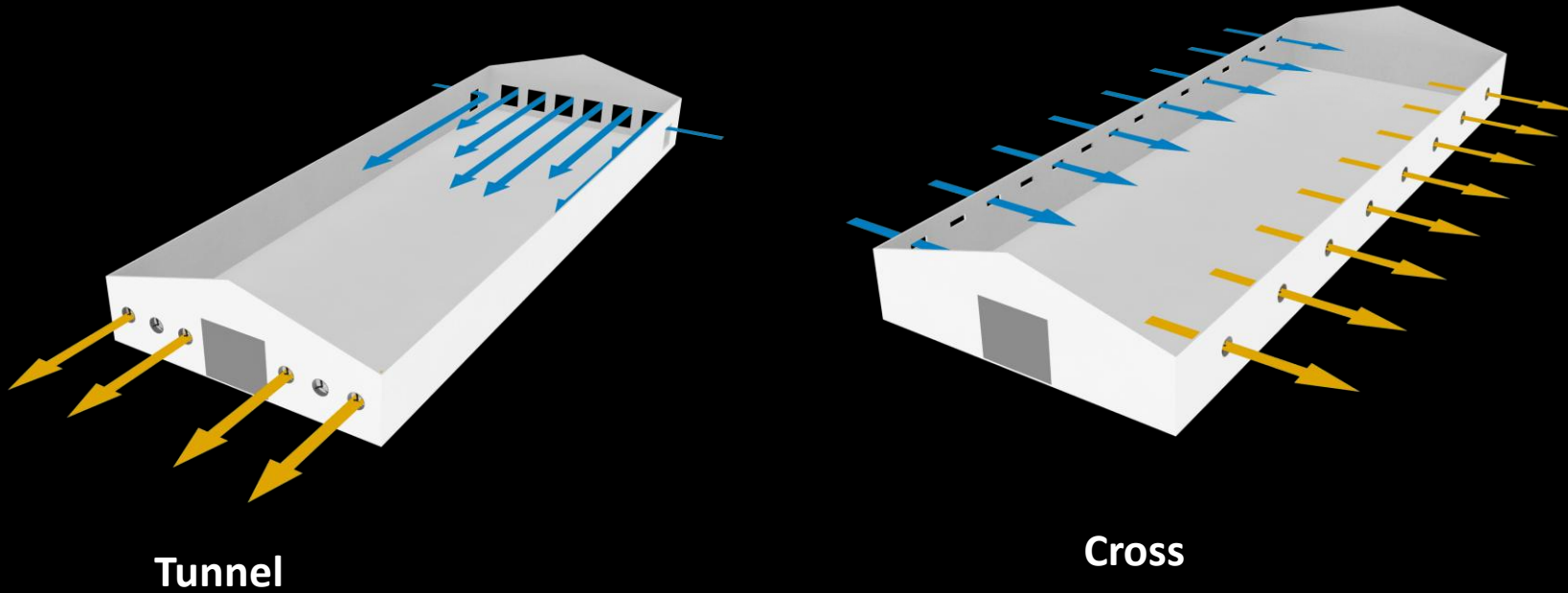

Consentono di controllare precisamente ricambi d'aria (e velocità)  
Costi di costruzione ed esercizio (€/kWh)



Cross ventilated low profile



Tunnel ventilated barn



Positive pressure hybrid ventilation (Gordon Jones)







**NH<sub>3</sub> <3.5 - 7 ppm**  
**Misurato @ 0.5 m**

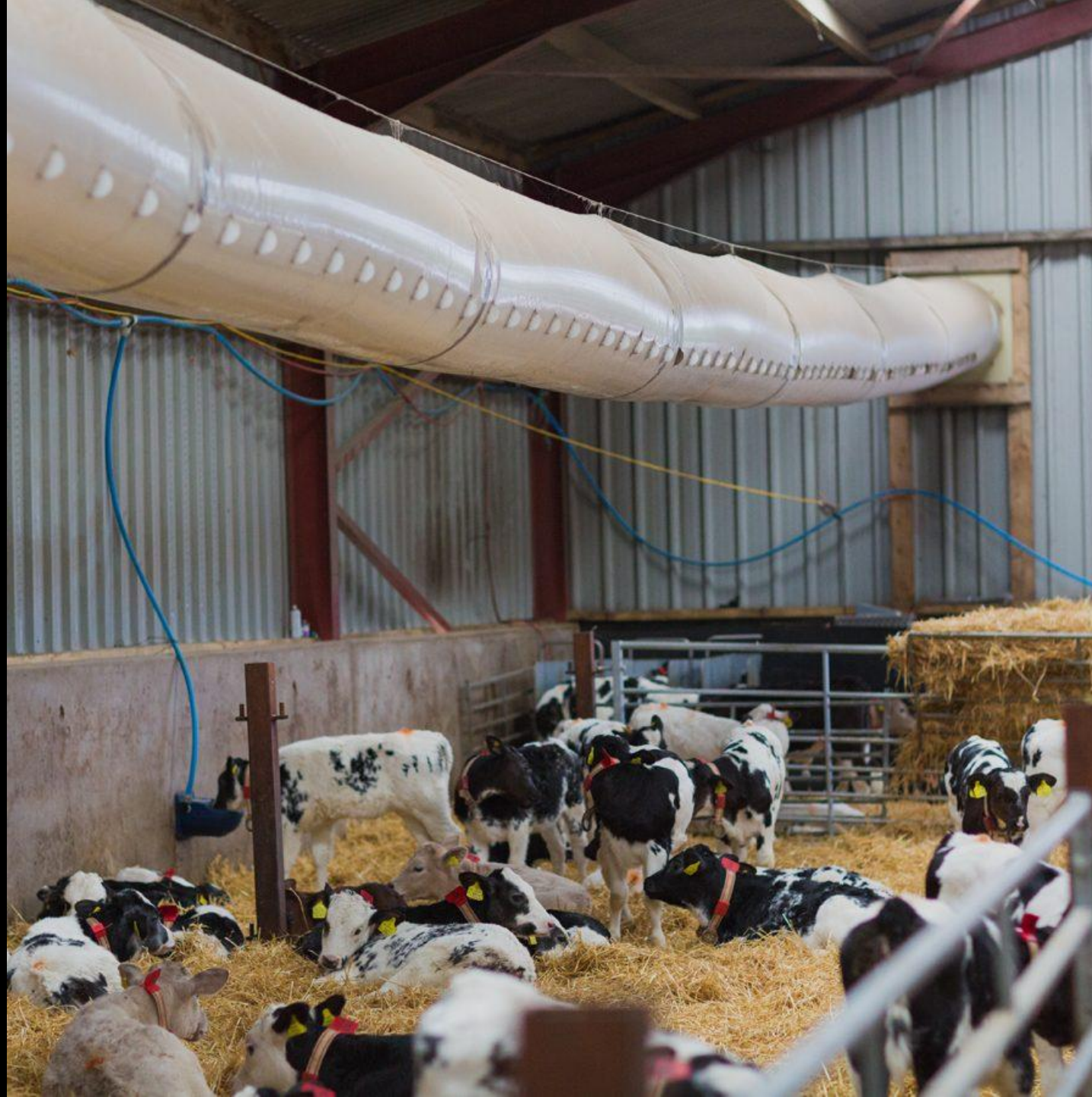

A photograph of a cow in a barn. The cow is black and white, standing in a stall. The background shows a corrugated metal roof and some greenery outside. The lighting is somewhat dim, suggesting an indoor setting.

## ACQUA DI RAFFRESCAMENTO

---

- I sistemi sprinkler a bassa pressione (goccia pesante) devono funzionare in modo intermittente:
- 1-2min: bagnatura animali (fino alla pelle)
- 4-15 min: asciugatura con ventilazione
- Il calore viene asportato più efficientemente quando gli irrigatori sono spenti e l'acqua evapora.

E la doccia?



# TAKE HOME MESSAGES

- Una corretta **ventilazione** è **fondamentale per benessere animale**
- PRIORITA' VENTILAZIONE SU AREE DI RIPOSO
  - **>1 m/s** su tutte le cuccette/lettiere
    - Per mantenere tempo di riposo (in estate)
    - Per asciugare le lettiere (sia in estate che in inverno)
- Favorire il ricambio d'aria nella stalla è importante quanto incrementare la velocità dell'aria (**60 AEH**)
  - Stalle a ventilazione meccanica in Italia... (**€/kW**)
- Nuovi sistemi di controllo ventilazione basati su concentrazioni di gas (indoor vs outdoor mass balance) oltre che su THI

**GRAZIE. DOMANDE?**

